

# Accessories / Zubehör



2023

**Fig. Z01.01 Protectors / Protektoren**



**1**



**2**



**3**



**5**



**4**



**6**

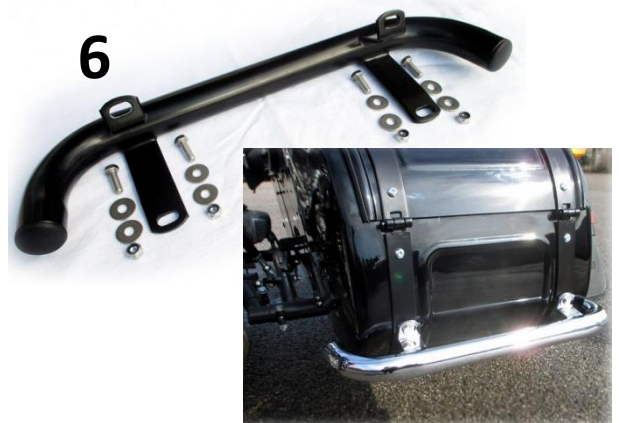

**7**



**8**



**9**



**Fig. Z01.02 Protectors / Protektoren**



**1**



**2**



**3**



**4**



**4**



**Fig. Z02.01 Luggage racks / Gepäckträger**

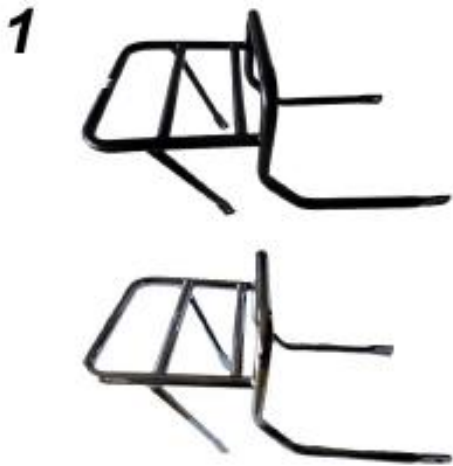

**Fig. Z02.02 Luggage racks / Gepäckträger**



**1**



**2**



**3**



**4**



**Fig. Z02.03 Luggage racks / Gepäckträger**



**1**



**2**



**3**



**4**



**System Baraholka (parts)**

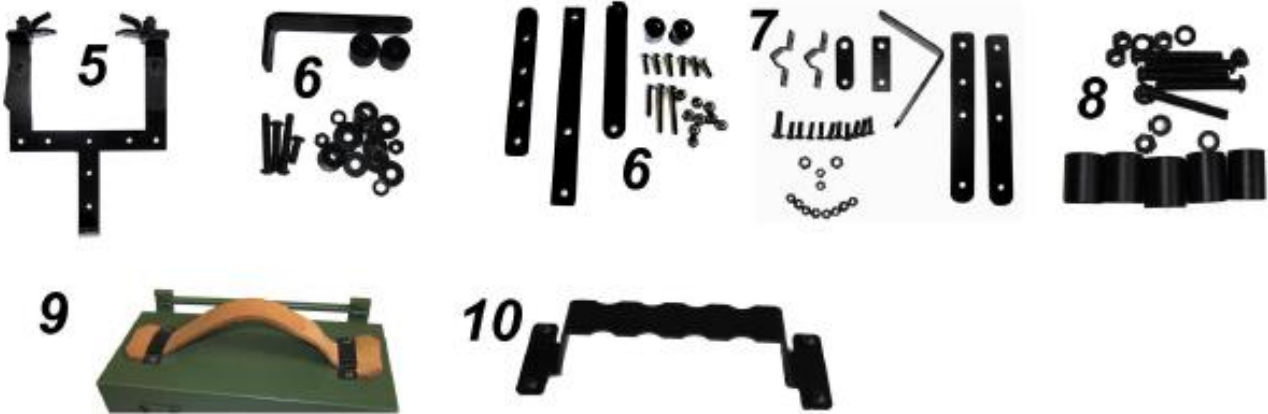

**Boxes are delivered without logo, please choose one of these: suitable for Baraholka and first aid boxes (attached with screws)**



## **System Baraholka (mounting)**



**Retro with luggage rack =  
IDE40 + IDE48 + IDE49**



**Retro without rack =  
IDE40 + IDE48**



**Ranger, Tourist, Sportsman = IDE40 + IDE47**





# Z03.03 Luggage systems / Gepäcksysteme



# Z03.04 Luggage systems / Gepäcksysteme



# Z03.05 Luggage systems / Gepäcksysteme



1

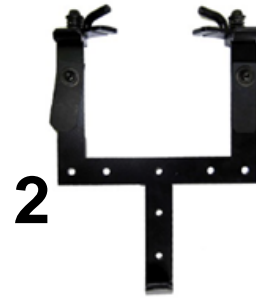

2



3



4



5



6

**Fig. Z04.01 Seats / Sitze**



**Fig. Z04.02 Seats / Sitze**



**13 = 10+11+12**

**Fig. Z04.03 Seats / Sitze**



**Fig. Z05.01 Comfort / Komfort**



**Fig. Z05.02 Comfort / Komfort**





**Fig. Z05.03 Comfort / Komfort**



**1**



**Fig. Z06.01 Complete wheels / Räder komplett**

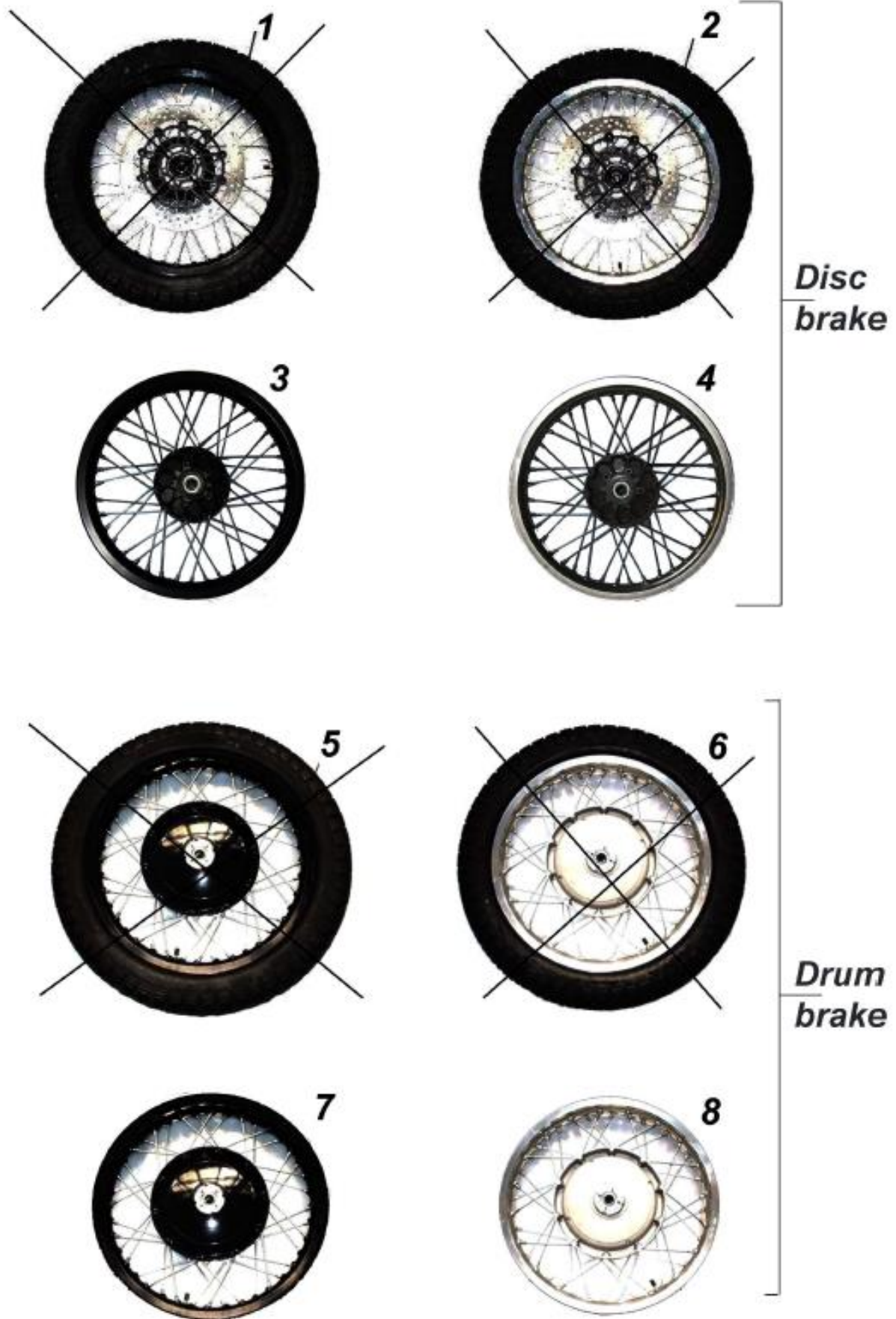

# Fig. Z06.02 Tires / Reifen



**Enduro K37 19"**  
**Enduro K37 19" M+S**  
**Enduro K37 19" M+S / Spike**



**Enduro K67 18"**  
**Enduro K67 18" / Spike**



**Road Avon 18"**



**Road Avon 19"**



**Road Uralshina 19"**



**Road K34 19"**



**Road K36 18"**



**Road K28 18"**

# Fig. Z06.03 Rims / Felgen



**1**  
*Tube 18" / Tube 19"*



**2**  
*Rim band 18/19"  
Felgenband 18/19"*



**3**



**4**



**5**



**6**



**7**



**8**

**9**



**Fig. Z07.01 Windscreens / Windschilder**



**1**



**2**



**3**



**Fig. Z07.02 Windscreens / Windschilder**

**1**



**6**



**2**



**3**



**4**



**5**



**Fig. Z08.01 Exhaust systems / Auspuffanlagen**

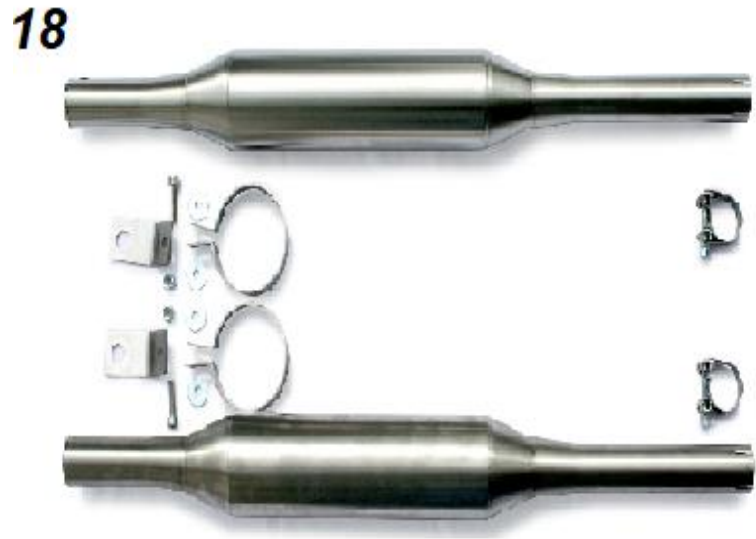
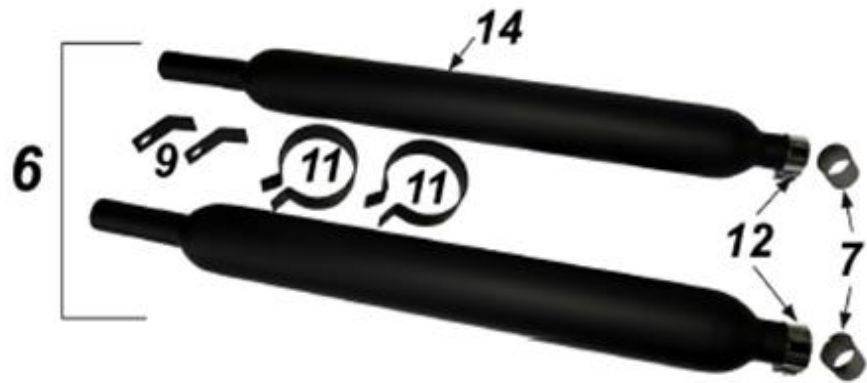
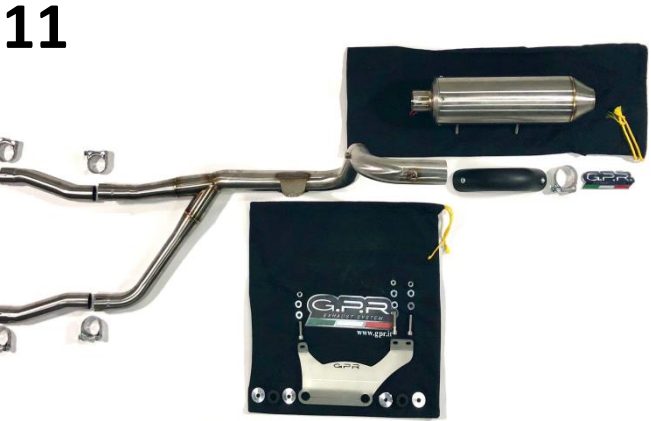
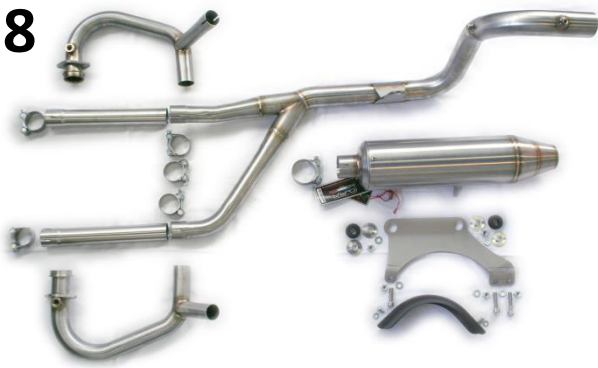

Fig. Z08.02 Exhaust systems / Auspuffanlagen







## Ducati ignition

1



2



3



4



5



6





1



3



4



5



6



7



8



Adapter KP33

9



10



11



12



13



14



15



16



17



# Z09.03 Tuning parts and Upgrades /

## Tuning Teile und Upgrades



# Z09.04 Tuning parts and Upgrades /

## Tuning Teile und Upgrades



# Z09.05 Tuning parts and Upgrades /

## Tuning Teile und Upgrades

---



1



2

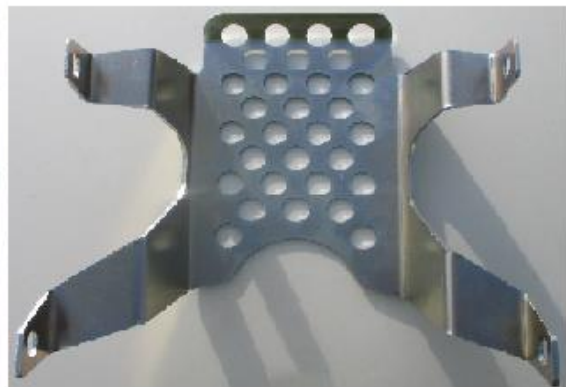

**Fig. Z10.01 Lighting / Beleuchtung**



**Fig. Z10.02 Lighting / Beleuchtung**

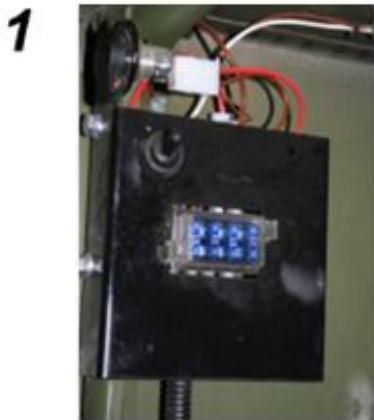

**Fig. Z10.03 Lighting / Beleuchtung**



**1**



**2**





# Fig. Z11.01 Vehicle protection and care / Fahrzeugschutz und Pflege



1



2



3



4



5



# Fig. Z11.02 Vehicle protection and care / Fahrzeugschutz und Pflege

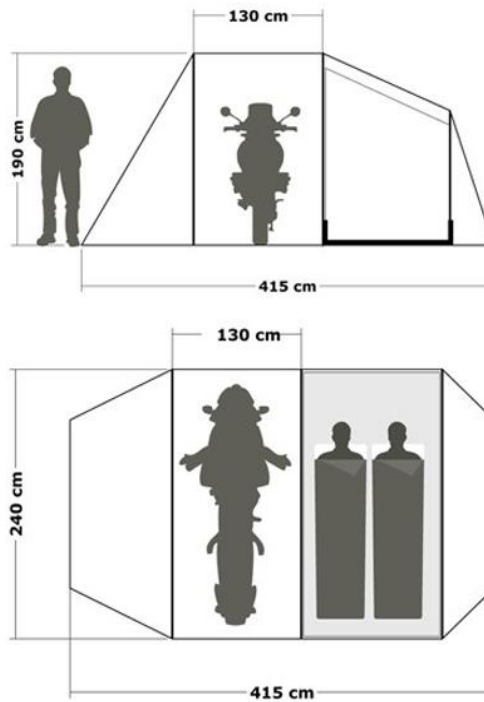

# Z12.01 Apparel / Bekleidung



# Z12.02 Apparel / Bekleidung



## Z12.03 Apparel / Bekleidung



1



2



3



# Z12.04 Apparel / Bekleidung



1



2

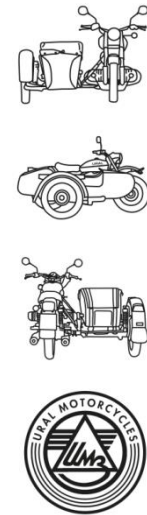

URAL MOTORCYCLES

3

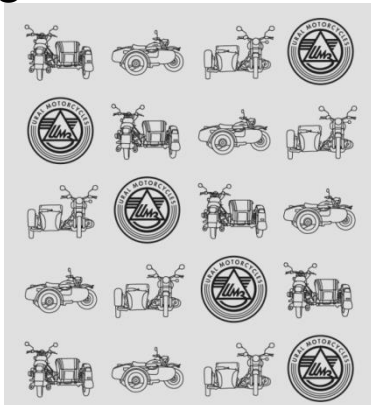

Turn Inside Out	Grab Ends	Pull Through	Pirate	Neck Scarf	Headband	Wiperband	Hair Tie	Fanny Towel	Face Mask
Turn Inside Out	Twist	Pull Down	Beanie	Alice Band	Bandana	Hair Cover	Hood	Balaclava	AND MORE!

MATERIAL: 100% RPET       MADE IN CHINA    MOB PO BOX 644, 6710 BP (NL)    114103

# Z12.05 Apparel / Bekleidung



1



# Z13.01 Accessories, Memorabilia / Zubehör, Fanartikel





# Z13.02 Accessories, Memorabilia / Zubehör, Fanartikel



**Fig. Z13.03 Accessoires, Memorabilia / Zubehör, Fanartikel**



1

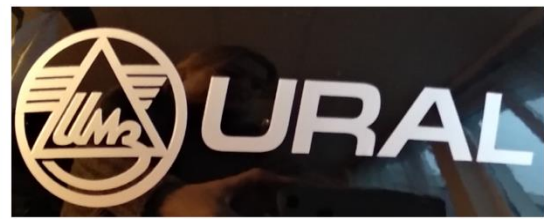

2



3



5

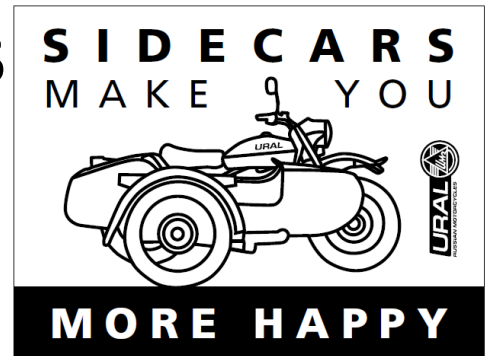

4



# Z13.04 Accessories, Memorabilia / Zubehör, Fanartikel



# Fig. Z13.05 Accessoires, Memorabilia / Zubehör, Fanartikel



1

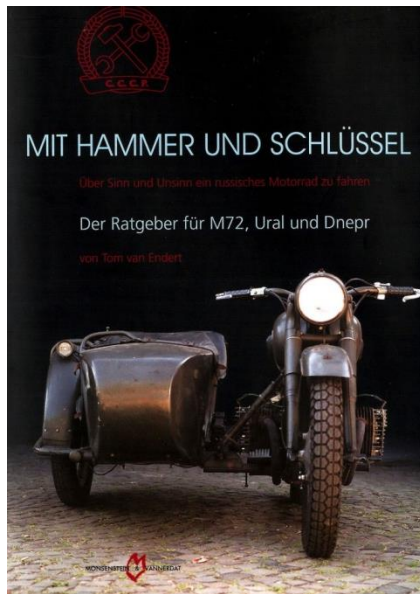

2

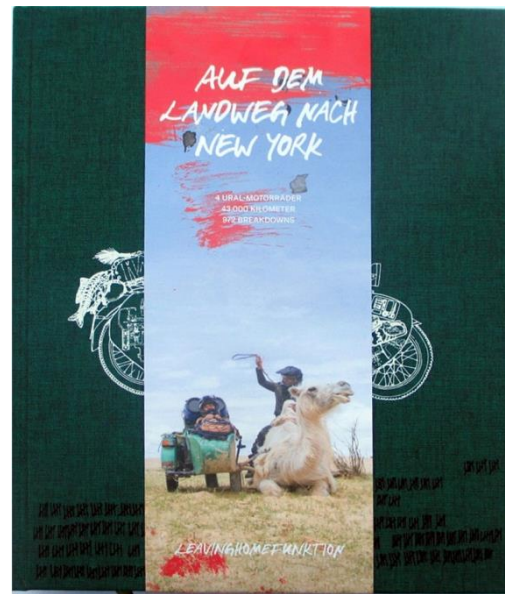

3

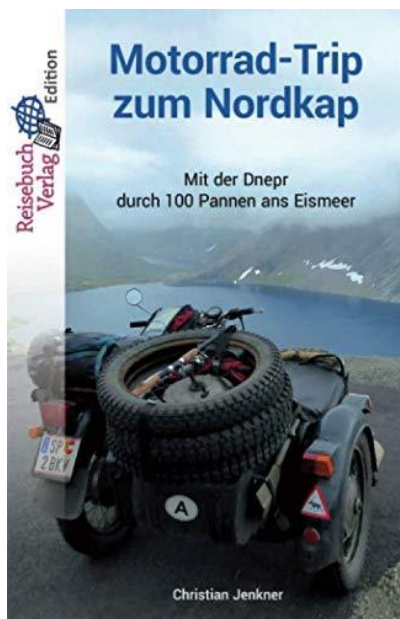

4

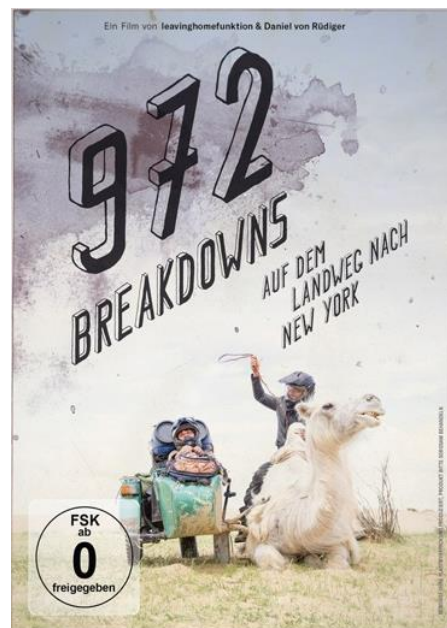

# Z14.01 Trailer / Anhänger

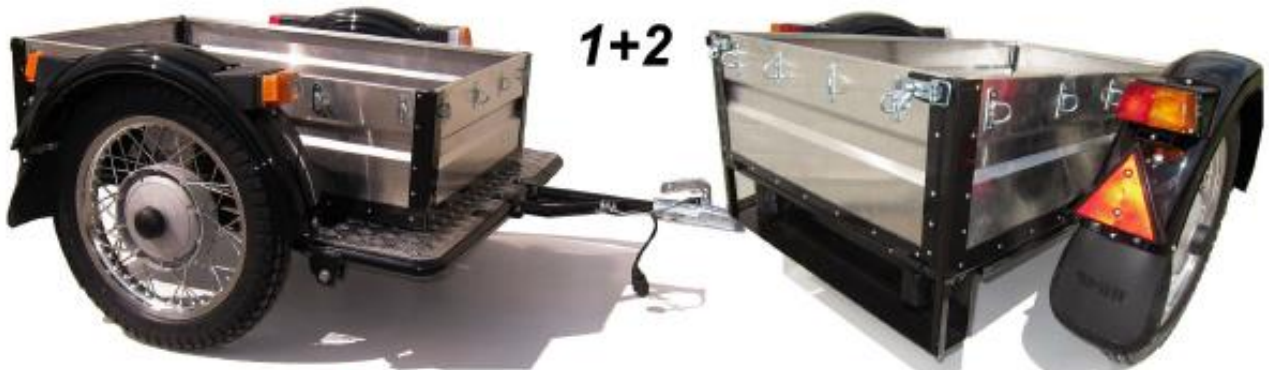

# Z15.01 Cross sidecar kit / Cross Beiwagen Kit



1



2



3



4



5



6



**Fig. Z17.01 Purchase facilities / Kaufhilfen**





# Fig. Z18.01 EFI diagnostic tools / EFI Diagnosetools



until/bis 2016



2017-2018



# Fig. Z18.02 EFI diagnostic tools / EFI Diagnosetools



from/ab 2019

1



2



3

